

途研(苏州)精密机械科技有限公司

TUYAN (SUZHOU) TECHNOLOGY CO., LTD

超硬特殊工具のスペシャリスト
蘇州塗研(そしゅうとけん)会社紹介資料



会社概況



途研精工は2011年に成立され、高精密度特殊金属切削工具の設計、生産、販売及びアフターサービスを完備しています。

弊社は先端な生産及び検査設備を10セット以上保有し、生産された高精密度、汎用性も高い特殊工具は主に自動車業界、航空業界、金型加工、工程機械など様々な分野で活躍されている。それと共に、弊社も業界内有名な刃物メーカーに代行加工サービスも提供し、今まで、当社は何れにせよ幅広く客先から好評され、愛顧されました。

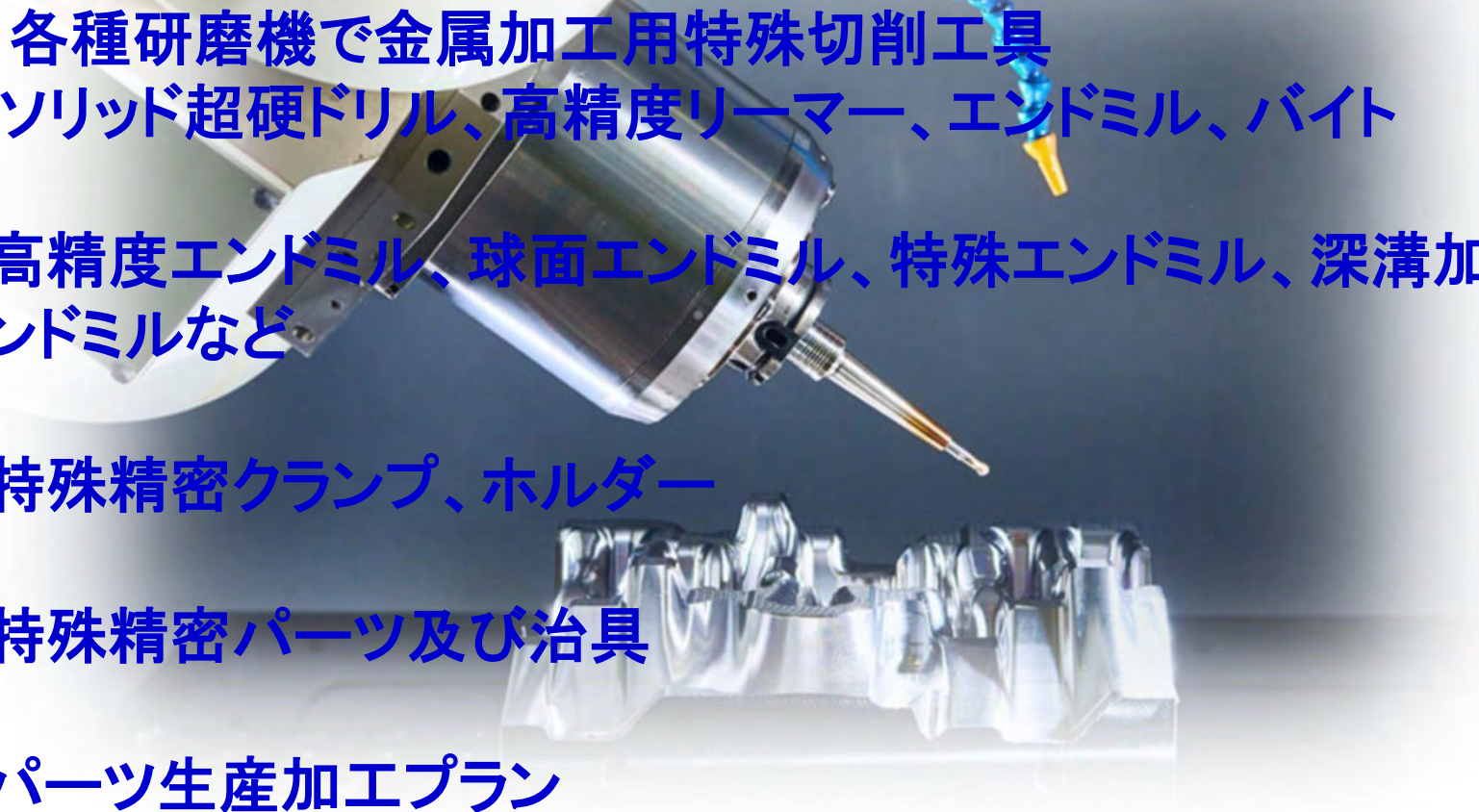

販売範囲

1. 各種研磨機で金属加工用特殊切削工具
ソリッド超硬ドリル、高精度リーマー、エンドミル、バイト
 2. 高精度エンドミル、球面エンドミル、特殊エンドミル、深溝加工エンドミルなど
 3. 特殊精密クランプ、ホルダー
 4. 特殊精密パーツ及び治具
 5. パーツ生産加工プラン
- 

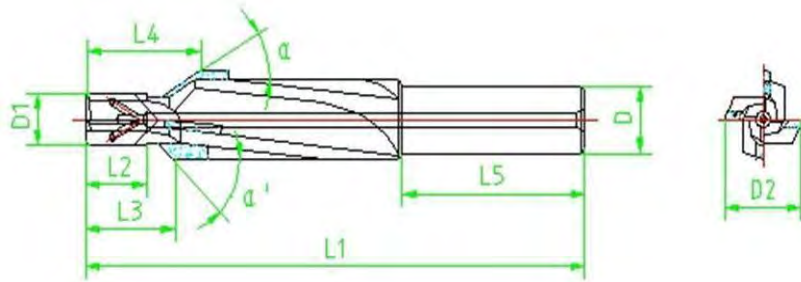

ロー付け式ガイド付ドリル

組み合わせ式ドリル

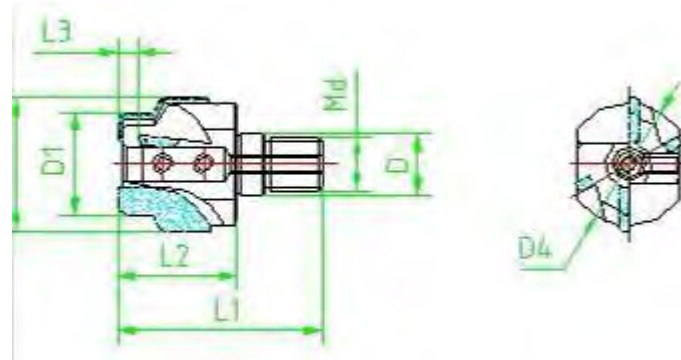

ロー付け
複合工具

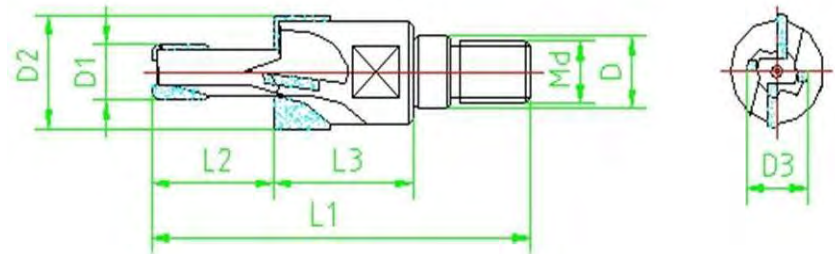

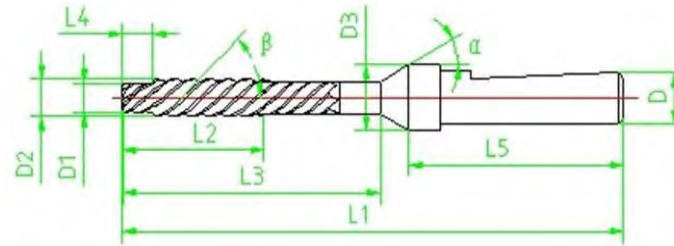

段付きリーマ

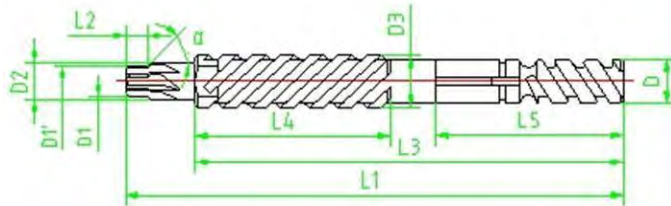

スパイラルリーマ



合金リーマ

ロー付けテーパ付きスパイラルリーマ

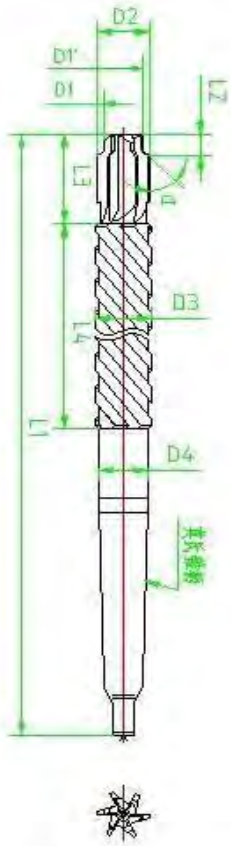

ロー付け式段付きリーマ

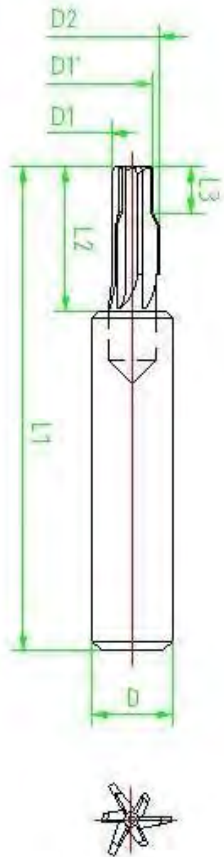

6枚刃合金総合リーマ

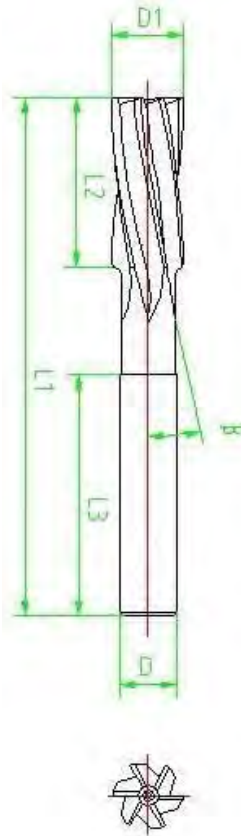

ロー付け式アシメトリックリーマ

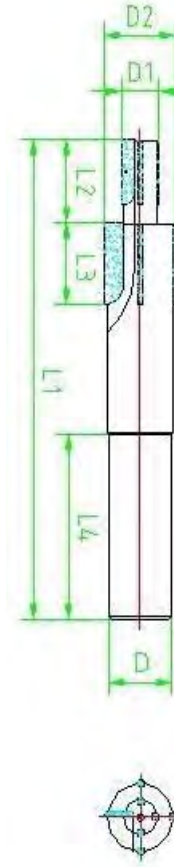

アシメトリックホルダー付きリーマ

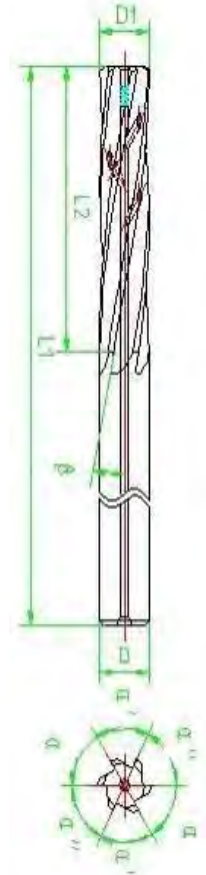

オイル(OH)
段付きドリル

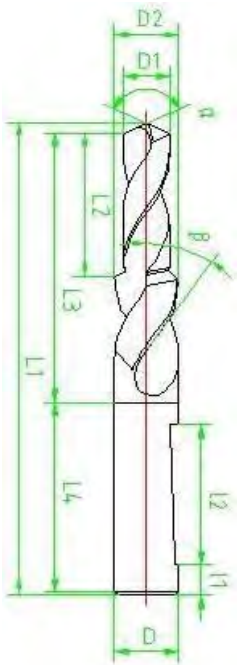

3枚刃3段付き
ドリル

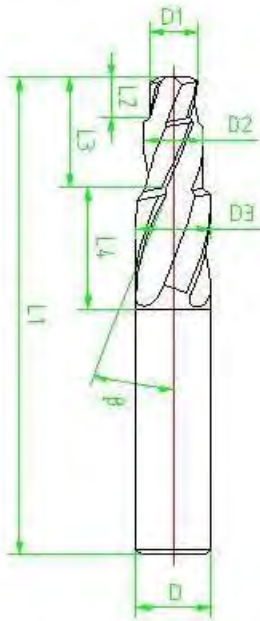

オイル(OH)
段付きスト
レートドリル

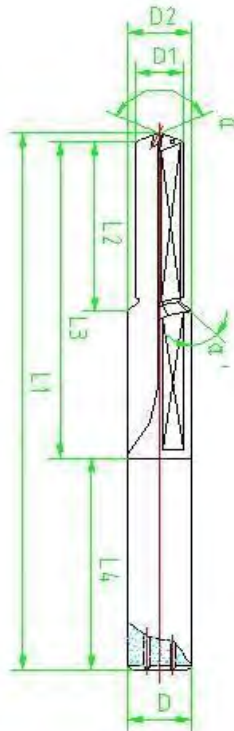

合金G
ドリル

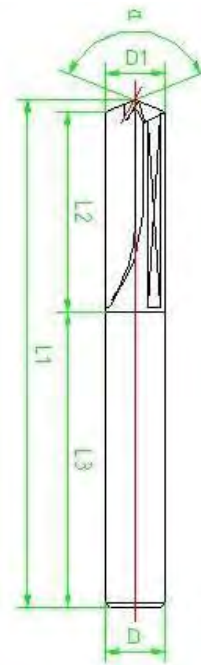

3段付きスト
レートドリル

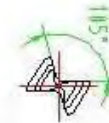
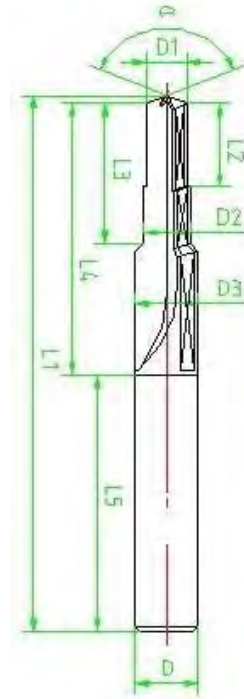

ロー付け式
段付きスト
レートドリル

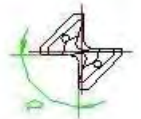
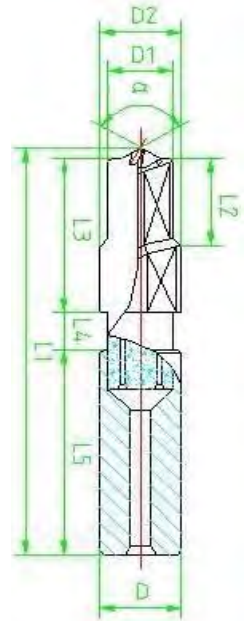

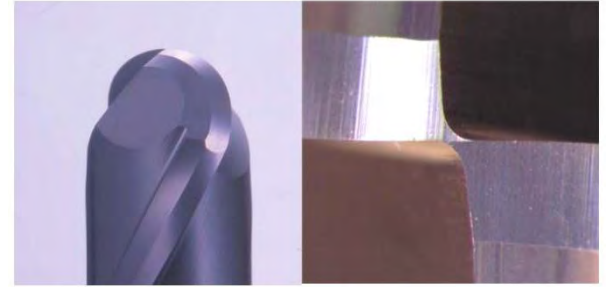
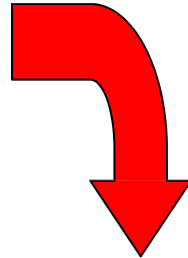
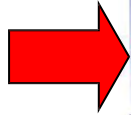

R 精度完璧!

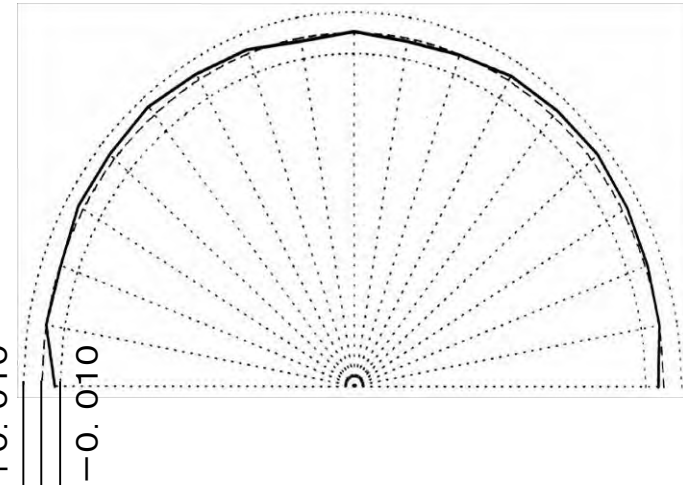
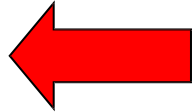
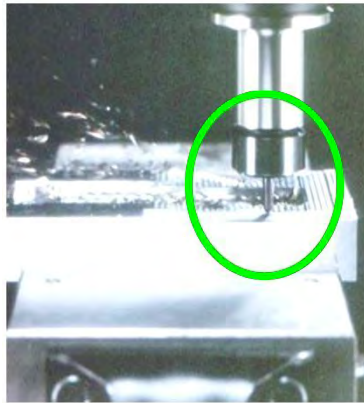

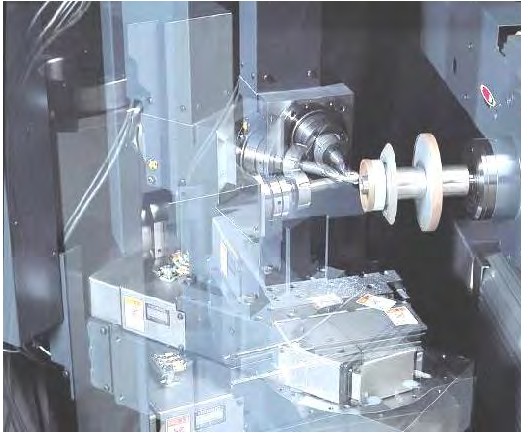

途研精工の球面
カッター加工方法

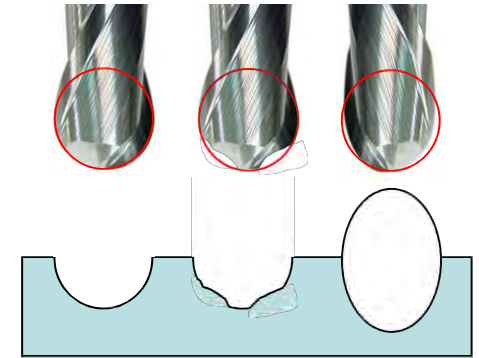

PERFECT

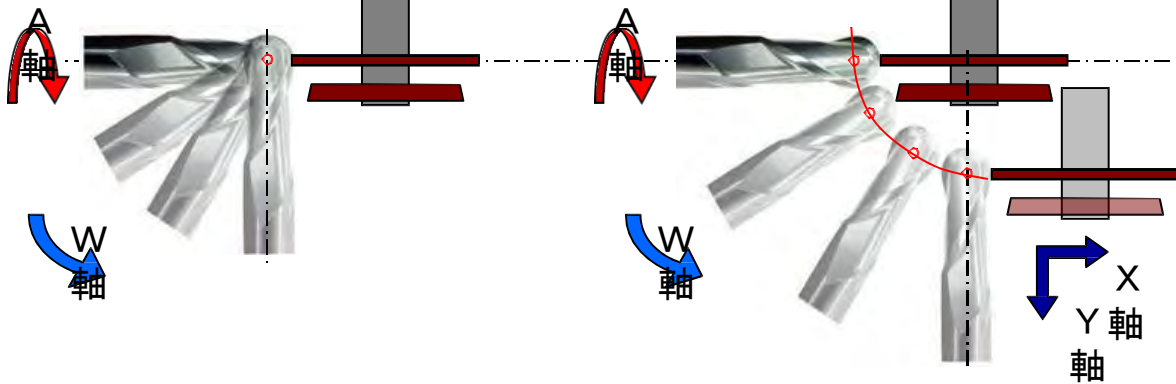

他社の球面カッター加工方法

NOT GOOD









技術エンジニア
は皆15年以上の刃物
設計、製造経験持ち。

加工設備はす
べて世界トップの牧
野精工を使用する。

刃物設計製造ソフト
ウェアは牧野精工の
MSPS IIシステムを使
用， 3D 設計ソフト
ウェアSOLIDWORKSの協
力によって複雑な特
殊工具の設計や製造
を可能になる。

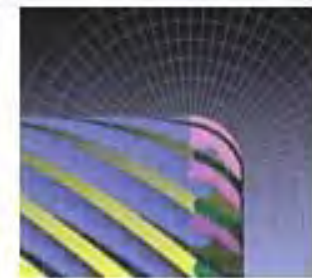
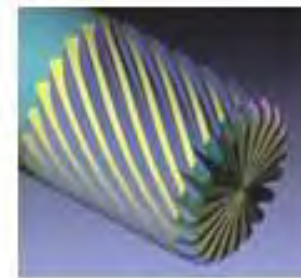
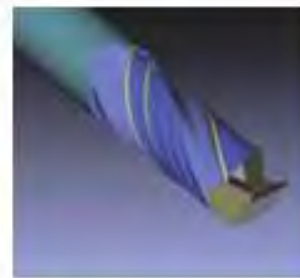
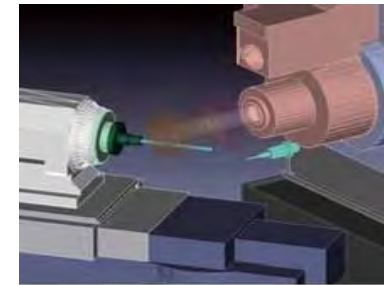
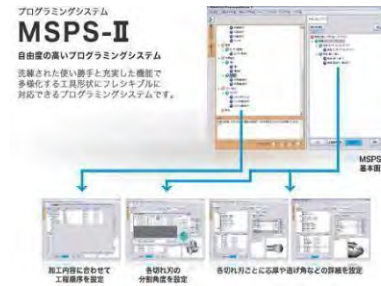

原材料

u ドイツから輸入された汎用性高い超硬材料

高硬度: HRA94以上

曲げ強度: 3900 N/mm²

マイクロ結晶粒: 0.2 μ ~0.5 μ

コーティング

u 加工ワークと切削条件によって最適なコーティングを選定する

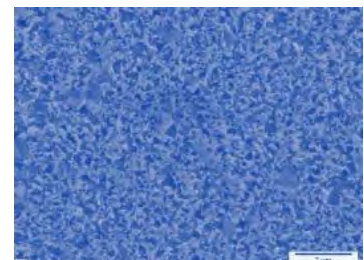
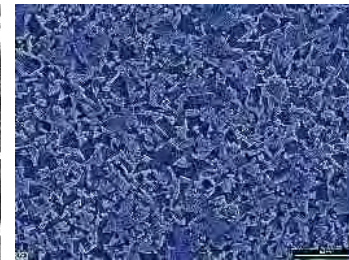
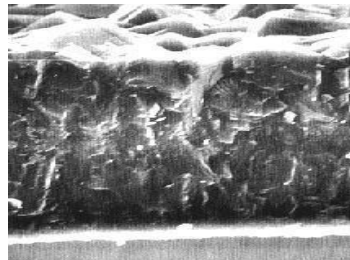
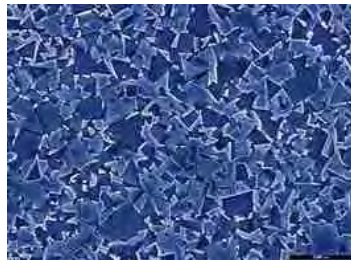
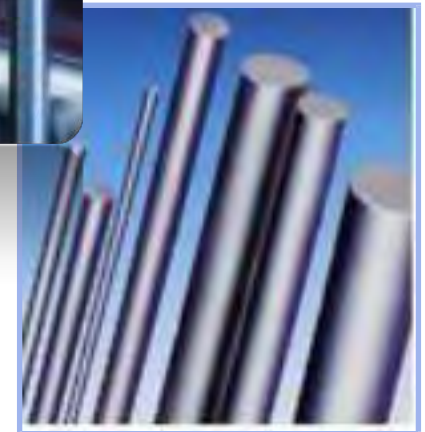





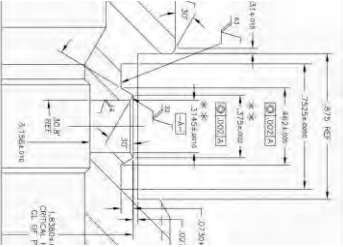

受注

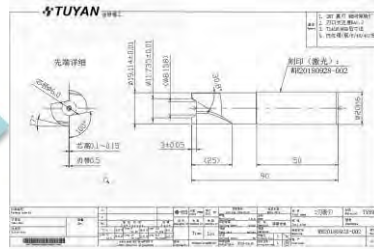

出図、図面確認



製作



検査



梱包



出荷



納品